

TGT79 TOUCH SCREEN THERMOSTAT

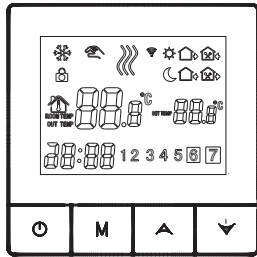

I. Product Summary:

The digital heating liquid crystal temperature controller adopts the most advanced microcomputer control chip in the world, and detects the temperature through a high-precision sensor inside the thermostat. And in real time, compared with the temperature set by the user, the load (electric heating device or valve) is automatically turned on and off to achieve the purpose of maintaining the indoor constant temperature.

II. Technical Parameter:

Power Supply	200 ~ 240V 50 ~60Hz
Current Load	≤3A (water heating/gas boiler) ≤16A(electric heating)
Power Consumption	<0.3W
Sensing Element	NTC
Set Temp. Range	5-60°C
Accuracy	±0.5°C

III. Main Functions and Characteristics

1. Large screen display and touch button
2. Power-off memory function
3. Real-time data save function
4. 5+2 or 6+1 or 7days six periods program schedule
5. Anti-freezing function
6. 3 sensor modes can be setting
7. Selectable 80mmx80mm European hidden box.
8. With child lock function

IV. Button Function

- Power on/off;
- M** Mode button: switch manual, automatic time control, temporary manual, long press time, hour, minute, week settings.
- Upper button: temperature plus, plus parameters;
- Lower button: temperature minus, minus parameter.

V. Display and Function Description

- Manual control, flashing for temporary manual control, no display for automatic control
- Heating
- The first period, get up in the morning;
- The second time, go out in the morning;
- The third time, go home at noon;
- The fourth time, go out at noon;
- The fifth time, go home at night;
- The sixth period, sleep at night;
- The antifreeze function is turned on.
- Press **M** and unlock or unlock at the same time.

VI. Model Specific

Model	Current Loading	External Sensor	Week Program	Controlled Objects
TGT79WIFI-EP	16A	✓	✓	For electric heating appliances
TGT79WIFI-WP	3A		✓	For water heating appliances
TGT79WIFI-WPB	3A		✓	For gas boiler heating appliances

VII. User Interface Explanation

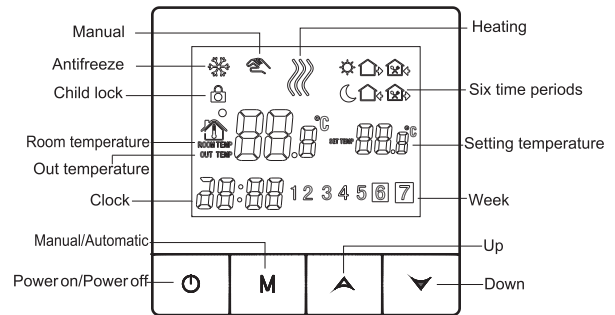

VIII. Wiring Diagram

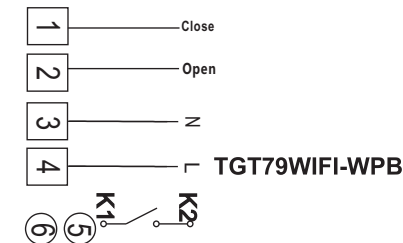
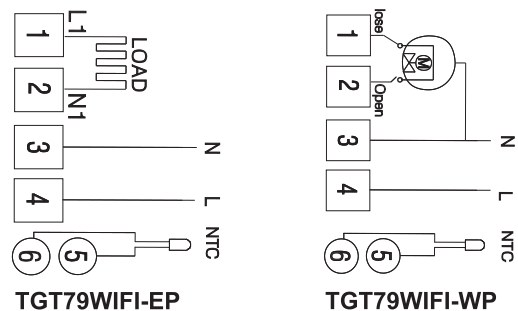

IX. Operation Instruction

- 1. Setting Power on/off**
Press to turn on/off the power.
- 2. Setting Temperature**
Press to set the temperature.
- 3. Setting the Clock**
Press the **M** key for 3 seconds to set the minutes, hours, and weeks.
Press for adjusting.
- 4. Setting the Manual Mode.**
Manual mode means non-programmable mode.
Press **M**, then will display in the screen, it is in manual mode.
Press to set the temperature.
Press the **M** key for 3 seconds to set the minutes, hours, and weeks.
- 5. Setting the Child Lock**
Press **M** and at the same time in the on state, will display.
Press **M** and at the same time in the on state again, will disappear.
- 6. Setting the Programmable Mode.**
Press the **M** and at the same time in the off state. LOOP and 12345 will display.
Press to select the control way: 5+2 or 6+1 or 7 days programmable.
12345 display in the position of week means 5+2;
123456 display in the position of week means 6+1;
1234567 display in the position of week means 7 days programmable.
Press **M** to do time adjustment.
Press to change the time;
Press **M** to select the periods.
Press to change the temperature ;
Press **M** again to do time adjustment.
 will disappear in automatic control state. You can directly press to adjust temperature, This will return to manual mode.

Press **M** to switch operation between manual mode and programmable mode.

Period	Period Icon	Defaulted Time	Defaulted Temp.
Week	1	6:00	20°C
	2	8:00	15°C
	3	11:30	15°C
	4	12:30	15°C
	5	17:30	22°C
	6	22:00	15°C
Weekend	1	8:00	22°C
	2	23:00	15°C

Remark:

- (1) The defaulted temperature of period3 and period4 is the same as period2. Please change it according to the request.
- (2) When setting temperature is 00, this period is power off.
- (3) How to check floor temp?
In the power on state, long press and hold **M** then press **⏻** to check floor temp., **OUT TEMP** will display.

7. Advanced Setting

In the state of power-off, long press and hold **M** then press **⏻** into advanced setting mode. Then press **M** to set relative item.

Display Code	Function	Setting And Options	Factory Default
SEN	Sensor mode	0:Internal sensor 1:Floor sensor 2:Both internal sensor and floor sensor	0
OSV	Set temp. range for floor sensor	5-99°C	42°C
DIF	Precision for floor temp.	1-9°C	2°C
SVH	High limit temp. for internal sensor	5-99°C	35°C
SVL	Low limit temp. for internal sensor	5-99°C	5°C
ADJ	Measure temp.	Check and calibrate the actual room temp.	0.5°C accuracy calibrate
FRE	Frost-protection	00 : Off 01 : On	00
PON	Power memory	00 : Off 01 : On	00
DFI	Precision for room temp.	0.5-3°C	1°C
Opt	Linkage terminal output direction	00:Set temp>Room temp, relay close 01:Set temp<Room temp, relay close	00: Positive output
FAC	Factory setting	08 : Just display 00 : Factory reset	08

Remark:

Antifreeze function: The thermostat is in the off state. When the indoor temperature is lower than 5 °C, the electric valve is opened. When the indoor temperature rises to 7 °C, the thermostat automatically turns off the output.

Sensor error:

Please select the right sensor mode. If select the different mode or there is error of sensor, Err will display on the LCD screen, the thermostat will stop heating till the problem is solved.

Special note:

installing cable please choose: plumbing 1.5-2.5mm2 hard wire.

X. WIFI Connection

For IOS system: Login in App Store, search " Smart Life "or "Tuya Smart", you can download it on your iphone.

For Android System: Login in Google Play, search " Smart Life ", or "Tuya Smart", you can download it on your phone.

Or scan below code to download:

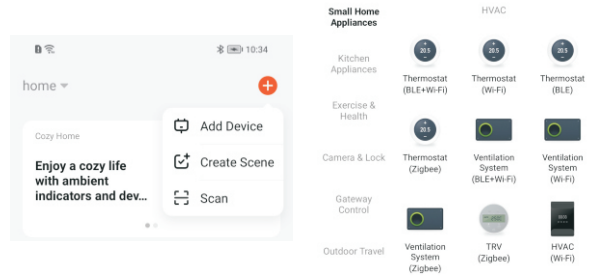

Click the Add Device button in the upper right corner, or click Add Device.

Be sure to turn on your phone's Bluetooth.

Only 2.4G status configuration can be added for WIFI access on mobile phones (the name and password can only use numbers and letters, not symbols).



In the power off state, press up **▲** and hold on for 10 seconds.

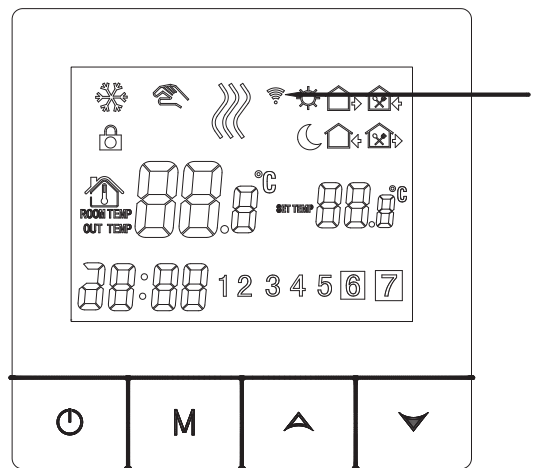

During configuration, the short blink is valid for 2 minutes (press the up key for 10 seconds when shutting down the machine repeatedly: slow flashing indicates AP network mode).

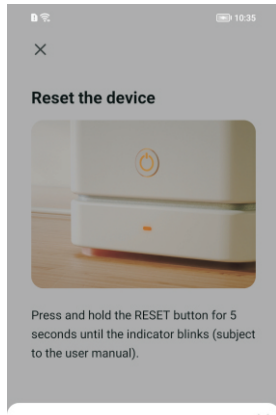
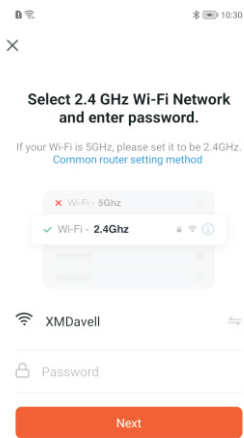

Select the status of the indicator light or hear the beep:

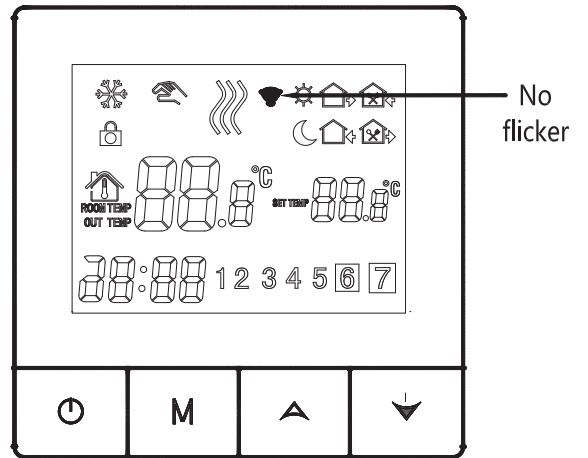
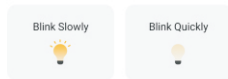

After the configuration is completed, the WiFi icon of the thermostat does not flash.

Enter the password and click Next

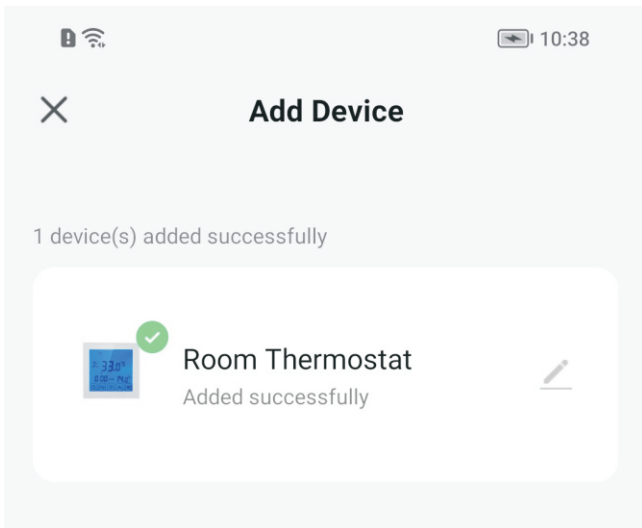

Wait 1-2 minutes for the device to connect. If no, check the mobile phone, route, thermostat, and network device.

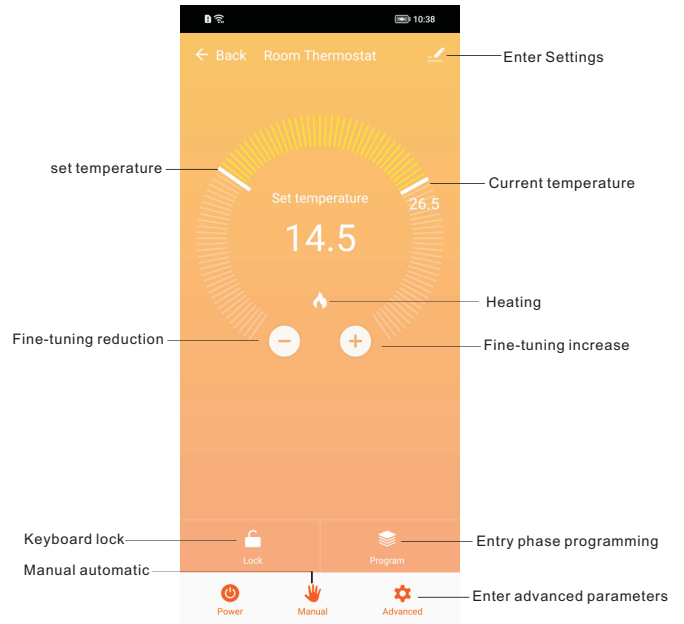

Control Page

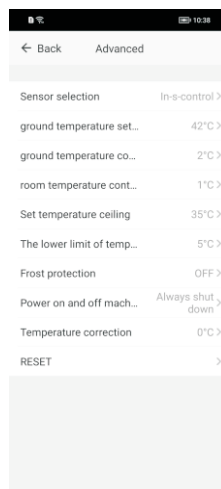

Divided into three kinds

In-s-control

Out-s-control

In-s-control , Out-s-control

— The value ranges from 5 to 99degrees

— The value ranges from 1 to 9 degrees

— The value ranges from 0.5 to 3 degrees

— The value ranges from 5 to 99 degrees

— The value ranges from 5 to 99 degrees

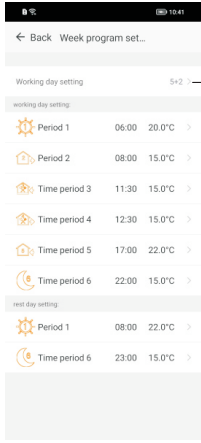

There are three modes
 5 + 2 means 5 working days and 2 rest days
 6 + 1 means 6 working days and 1 rest day
 7 means seven days in a week are working days

The workday is divided into 6 periods,
 And it can adjust the time and temperature

The rest day is divided into two periods,
 and the time and temperature can be adjusted

The main screen displays six time periods, click to modify the time period and temperature parameters.

XI. Installation Instruction

This product is suitable for standard 80*80mm wall box and 60 mm European round box.

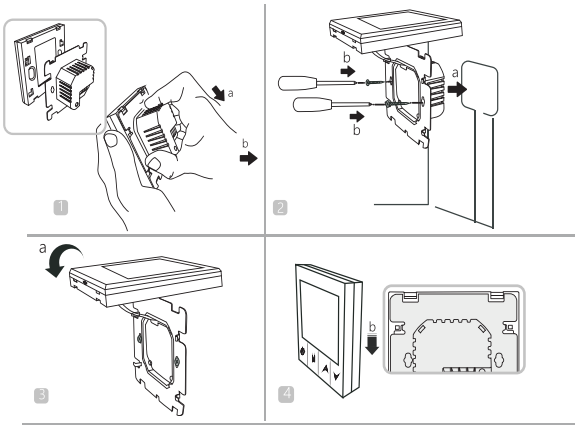

1. Open the main control board, use a 3.5mm wide vertebral slope to reach the depth of 4mm in the card slot, and lift it up slightly to open the hook.
2. Remove the back cover and power supply, wire it correctly according to the wiring diagram, and fix the back cover to the cassette with M4 screws.
3. Connect the lower cover cable to the upper cover board
4. Hang the upper two hooks at a 30-degree angle. Press the two corners below the thermostat slightly to lock the upper casing and the installation is complete.

NOTICE: Please strictly follow the wiring diagram and do not let the water, mud and other debris enter the thermostat, otherwise the thermostat will be damaged!

XII. ATT:

Thank you for buying this product!

Please read this manual for complete instructions on installing and operating your thermostat. If you require further assistance, please feel free to contact us.

In the box you will find:

Model	XXX-EP	XXX-WP/WPB
Thermostat	✓	✓
User Manual	✓	✓
Screws	✓	✓
External sensor	✓	

Our Service:

We offer the warranty of 24 months from the sales day.

During the warranty, if it is belong to the quality issue, we will fix or replace them for you by free after test them.

If it is not quality problem or beyond the warranty time, we will charge for the after-sales service.

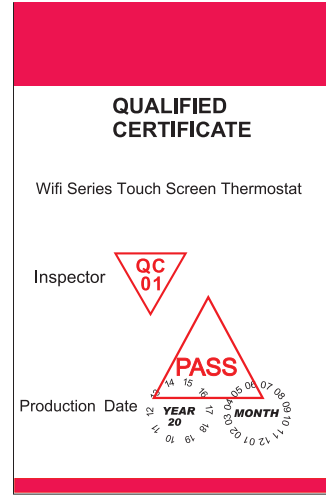

Warning:



The symbol means the unit is being installed, it may cause electrical shock hazard during maintaining, so please make sure it is operated by the professional technical worker.

